



INSIDE WATER

IW-DOSE



USER'S MANUAL





**DICHIARAZIONE DI CONFORMITA' - DECLARATION OF CONFORMITY
DECLARATION DE CONFORMITÉ - DECLARACIÓN DE CONFORMIDAD
KONFORMITÄTSEKTLÄRUNG**

Il prodotto - The product - Le produit - El producto - Das produkt:	IW-DOSE
---	---------

Risponde alle principali caratteristiche delle seguenti direttive europee:

- 2014/30/CE del 26/02/2014 - Armonizzazione delle legislazioni degli Stati membri relative alla compatibilità elettromagnetica - Direttiva EMC
- 2014/35/CE del 26/02/2014 - Armonizzazione delle legislazioni degli Stati membri relative alla messa a disposizione sul mercato del materiale elettrico destinato a essere adoperato entro taluni limiti di tensione - Direttiva BASSA TENSIONE
- 2011/65/UE del 08/06/2011 con successivo aggiornamento 2015/863 del 31/03/2015 - Direttiva ROHS III
- 2012/19/UE del 04/07/2012 - Direttiva RAEE per i rifiuti elettrici ed elettronici

<p>EN Respond to the principal features of the following European Directives:</p> <ul style="list-style-type: none"> ○ 2014/30/CE of 26/02/2014 - Harmonization of the laws of the Member States relating to electromagnetic compatibility - EMC Directive ○ 2014/35/CE of 26/02/2014 - Harmonization of the laws of the Member States relating to the making available on the market of electrical equipment designed for use within certain voltage limits - Low Voltage Directive ○ 2011/65/UE of 08/06/2011 with subsequent update 2015/863 of 31/03/2015 - ROHS III Directives ○ 2012/19/UE of 04/07/2012 - WEEE Directives for electrical and electronic waste 	<p>FR Est conforme aux principales caractéristiques des directives européennes suivantes:</p> <ul style="list-style-type: none"> ○ 2014/30/CE du 26/02/2014 - Harmonisation des législations des États membres concernant la compatibilité électromagnétique - Directive EMC ○ 2014/35/CE du 26/02/2014 - Harmonisation des législations des États membres concernant la mise à disposition sur le marché de matériel électrique destiné à être employé dans certaines limites de tension - Directive BASSE TENSION ○ 2011/65/UE du 08/06/2011 et amendement 2015/863 du 31/03/2015 - Directive ROHS III ○ 2012/19/UE du 04/07/2012 - Directive DEEE relative aux déchets d'équipements électriques et électroniques
<p>ES Cumplen las principales exigencias de las siguientes directivas europeas:</p> <ul style="list-style-type: none"> ○ 2014/30/CE de 26/02/2014 - Armonización de las legislaciones de los Estados miembros en materia de compatibilidad electromagnética - Directiva EMC ○ 2014/35/CE de 26/02/2014 - Armonización de las legislaciones de los Estados miembros en materia de comercialización de material eléctrico destinado a utilizarse con determinados límites de tensión - Directiva BAJA TENSIÓN ○ 2011/65/UE de 08/06/2011 con su posterior modificación 2015/863 de 31/03/2015 - Directiva ROHS III ○ 2012/19/UE de 04/07/2012 - Directiva RAEE sobre residuos de aparatos eléctricos y electrónicos 	<p>DE Die wesentlichen Eigenschaften folgender europäischer Richtlinie erfüllen:</p> <ul style="list-style-type: none"> ○ 2014/30/CE vom 26/02/2014 - Harmonisierung der Rechtsvorschriften der Mitgliedstaaten über die elektromagnetische Verträglichkeit - EMV-Richtlinie ○ 2014/35/CE vom 26/02/2014 - Harmonisierung der Rechtsvorschriften der Mitgliedstaaten über die Bereitstellung elektrischer Betriebsmittel innerhalb bestimmter Spannungsgrenzen auf dem Markt - NIEDERSPANNUNGSRICHTLINIE ○ 2011/65/UE vom 08/06/2011 und ihre nachfolgende Aktualisierung 2015/863 vom 31/03/2015 - ROHS-Richtlinie III ○ 2012/19/UE vom 04/07/2012 - WEEE-Richtlinie über Elektro- und Elektronik-Altgeräte

San Martino in Rio - 22th, september, 2022

Emil Anceschi



è un brand di:
AQUA SPA

Via Tonino Crotti, 1 - 42018 San Martino in Rio (RE) - Italy

INDEX

1. GENERAL RULES.....	4
1.1 SHIPPING AND TRANSPORTING THE PUMP	4
1.2 INSTALLATION STANDARDS	4
1.3 PROPER USE OF THE PUMP	4
2. OPERATION	6
2.1 OVERALL DIMENSIONS.....	6
2.2 TECHNICAL FEATURES.....	6
2.3 HYDRAULIC FEATURES	7
2.4 PERFORMANCE GRAPHS.....	8
2.5 CONTENT OF THE PACKAGE (Standard version)	9
3. IW-DOSE / IW-DOSE pH(Rx)-CI(J).....	10
3.1 GENERIC PUMP CONTROLS	10
3.2 MEANING OF THE PUMP STATE LEDS.....	10
3.3 MEANING OF THE MULTI-FUNCTION BUTTON AND LED.....	11
5. ELECTRICAL CONNECTIONS.....	12
5.1 IW-DOSE / IW-DOSE pH(Rx) / IW-DOSE CL pumps.....	12
6. TROUBLESHOOTING.....	13
6.1 PROBLEM – CAUSE – SOLUTION.....	13
7. MAINTENANCE.....	13
7.1 CLEANING THE PUMP	13
7.2 PUMP MAINTENANCE.....	14
8. WARRANTY.....	14
EXPLODED VIEWS	15

1. GENERAL RULES

Carefully read the warnings listed below as they provide important information regarding the rules for installation, use and maintenance.

Please keep this manual carefully for further reference.

1.1 SHIPPING AND TRANSPORTING THE PUMP

The equipment must be transported in its original packaging, organized and built in such a way as to minimize shocks and to protect the protruding parts that can be damaged. If there is a need for transport after the equipment has already been installed (e.g. for a return for repair or replacement), reuse the original packaging or a sufficiently sturdy packaging with the equipment protected with absorbent material (eg bubble wrap). The external packaging must be such as to ensure the safety of the equipment in the event of a fall from 1 meter in height.

1.2 INSTALLATION STANDARDS

Install the dosing pump so that it is easily accessible whenever maintenance is required. Never obstruct the place where the dosing pump is located.

The servicing and maintenance of the dosing pump and all its accessories must always be carried out by qualified personnel.

AQUA SpA cannot be held responsible for damage to persons or things caused by poor installation or incorrect use of the dosing pump.



Check that the ground is fully functional and corresponds to the regulations in force. Make sure there is a high sensitivity differential switch (0.03 A). Check that the pump ratings are compatible with those of the mains supply. Never install the pump directly in parallel with inductive loads (eg motors / solenoid valves) but if necessary use an "insulation relay". Inside the pump there are two protections: a varistor and a fuse.

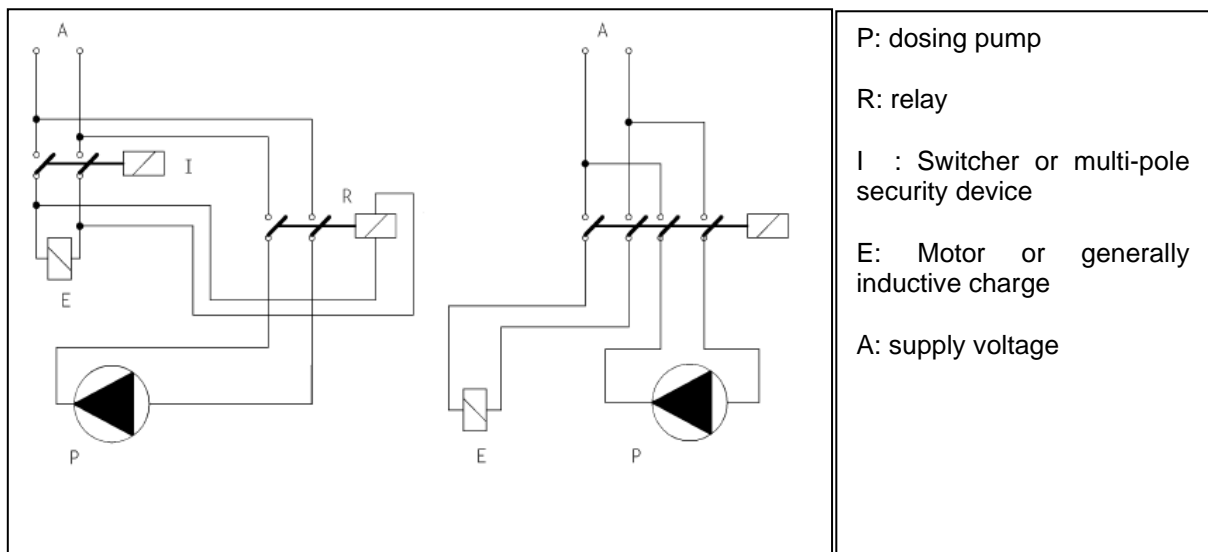

1.3 PROPER USE OF THE PUMP

The use of this pump must comply with the methods and instructions set out in this manual. The pump can dose chemicals that can be harmful to human health and for this reason it is essential that must be used by qualified personnel who adopt the appropriate safety methods and personal protective equipment.

AVOID IMPROPER USE of the equipment in order to avoid damage to things and people, due to uncontrolled splashes, drips, electrical contacts, etc.

The following uses can be considered improper uses, in indicative and non-exhaustive form:

- Dosing of products not consistent with the materials with which the pump is made;
- Dosing of explosive and / or flammable products;
- Dosing of fluids with excessive viscosity (1000 cps), such as to prevent the priming of the pump itself;
- Dosage of food liquids, if intended to maintain such use;
- Avoid inverting the pump delivery and suction;

- *Avoid powering the pump with voltages other than those indicated in the technical specifications;*
- *Avoid connecting any equipment other than specific equipment to the signal outputs (level, pulse counter, current signal, etc.);*

2. OPERATION

The IW-DOSE digital pumps are solenoid dosing pumps designed to be controlled remotely using our software. The pumps can be connected to an external signal or a probe that measure the physical-chemical parameters such as pH, ORP or free chlorine. The pump is also designed to connect a PT100 temperature sensor and a proximity sensor (not included in the package) to monitor the temperature and the presence of flow inside an electrode holder.

2.1 OVERALL DIMENSIONS

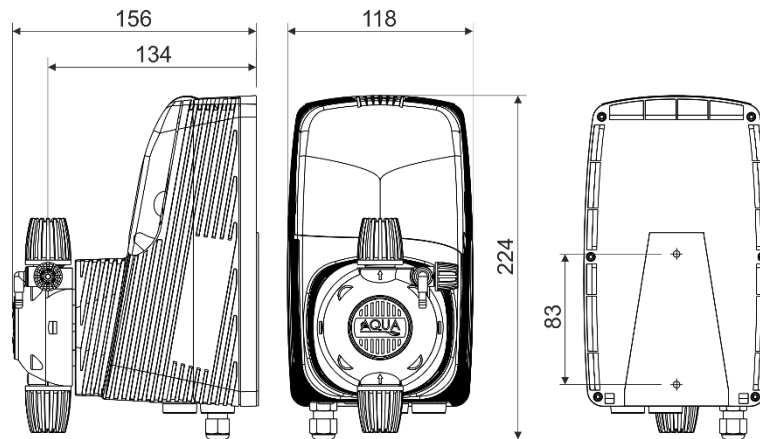

2.2 TECHNICAL FEATURES

Tensione di alimentazione - supply voltage - tension d'alimentation - voltaje de suministro - Versorgungsspannung	110÷230Vac 50-60Hz
Classe d'isolamento - Insulation class - Classe d'isolation - Clase de aislamiento - Isolationsklasse	 CLASSE I
Potenza assorbita - Absorbed power - Pouvoir absorbé - Potencia absorbida - Absorbierte Leistung	(230Vac) min 13W - max 35W (110Vac) min 18W - max 44W
Grado di protezione - Protection degree - Degré de protection - Grado de protección - Schutzgrad	IP 65



THIS UNIT MUST BE INSTALLED BY SPECIALIZED PERSONNEL. CAREFULLY FOLLOW THE INSTRUCTIONS OF THE USER MANUAL.



THE EQUIPMENT, SUBJECT TO THIS DOCUMENT, ARE NOT INTENDED TO BE INSTALLED AND USED IN EXPLOSIVE ATMOSPHERE ENVIRONMENTS. IT ISN'T AN ATEX PUMP.

2.3 HYDRAULIC FEATURES

Hydraulic characteristics of the 230V version

SOLENOID	TYPE	FLOW RATE	PRESSURE	STROKES	INJECTION VALUE	ABSORBED POWER
		l/h	bar		spm	ml/stroke
M60	A	1	7	100	0,17	13
		5	1		0,83	13
	B	3	7	150	0,33	16
		9	1		1	16
	C	5,5	6	180	0,51	22
		10	1		0,93	22
M70	A	1,8	20	75	0,40	18
		4	1		0,89	18
	B	4	12	120	0,56	25
		7	1		0,97	25
	C	5,8	9	180	0,54	27
		14	1		1,30	27
M80	A	4	20	150	0,44	24
		10	1		1,11	24
	B	6,5	12	200	0,54	27
		13	1		1,08	27
	C	13,5	5	300	0,75	35
		20	1		1,11	35

The above data refer to tests carried out with water at room temperature.

Values can fluctuate by 10%.

Chemicals with viscosity different than water may also have significant variations on the flow rate.

Hydraulic characteristics of the 110V version

SOLENOID	TYPE	FLOW RATE	PRESSURE	STROKES	INJECTION VALUE	ABSORBED POWER
		l/h	bar		spm	ml/stroke
M60	A	1,5	7	100	0,25	18
		5	1		0,83	18
	B	4,5	7	150	0,5	23
		7	1		0,78	23
	C	6	6	180	0,56	28
		8,8	1		0,81	28
M70	A	1	20	75	0,22	21
		4,5	1		1	21
	B	4	12	120	0,56	31
		7	1		0,97	31
	C	6,8	9	180	0,63	41
		10,8	1		1	41
M80	A	3	17	150	0,33	27
		10	1		1,11	27
	B	7,5	12	200	0,63	36
		13	1		1,08	36
	C	11	5	230	0,80	44
		16	1		1,16	44

The above data refer to tests carried out with water at room temperature.

Values can fluctuate by 10%.

Chemicals with viscosity different than water may also have significant variations on the flow rate.

2.4 PERFORMANCE GRAPHS

2.4.1 graphs relating to the 230V versions

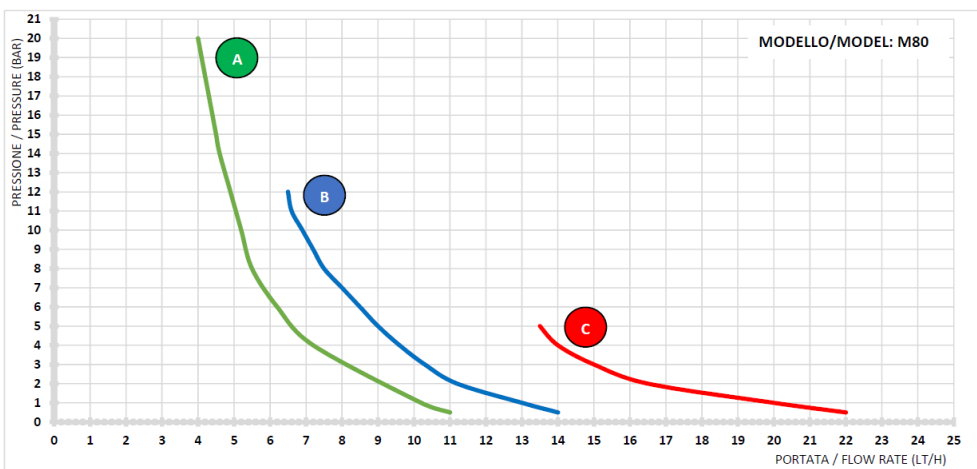
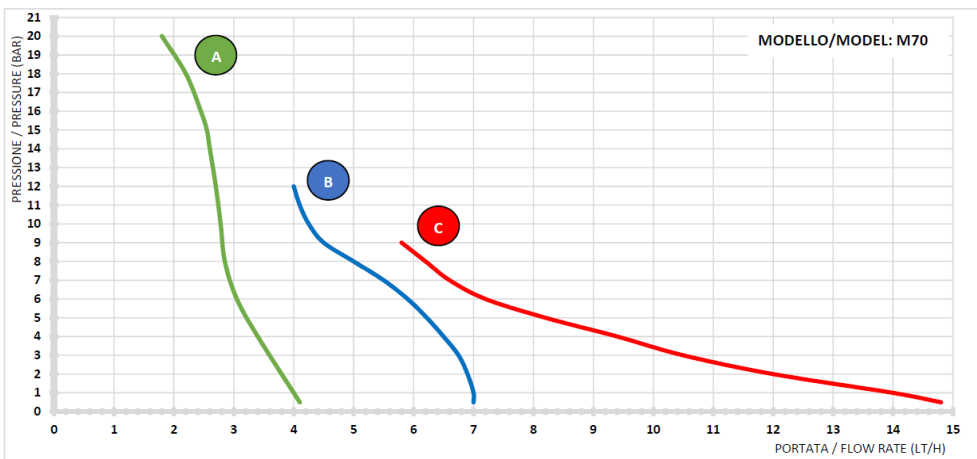
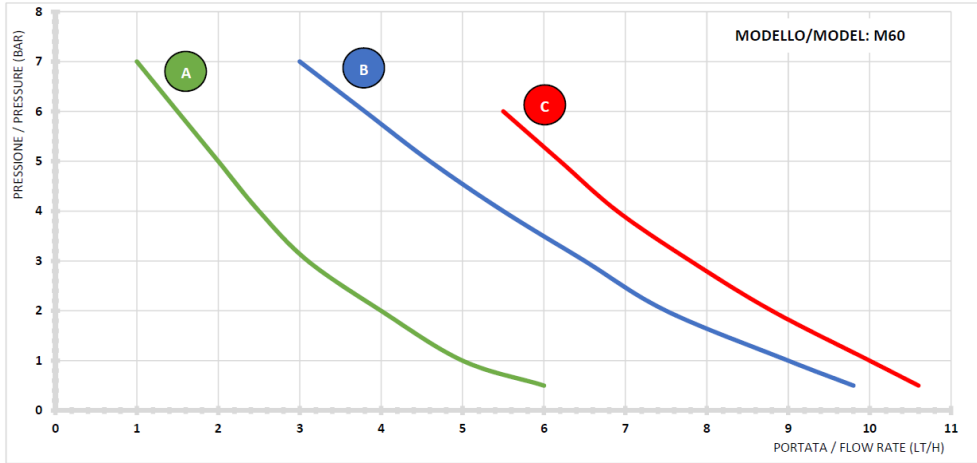

2.4.2 graphs relating to the 110V versions

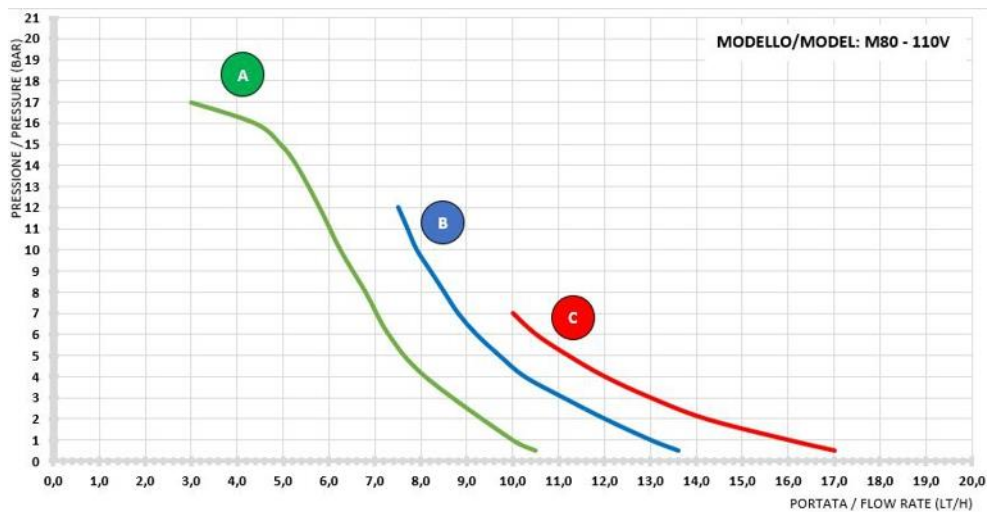
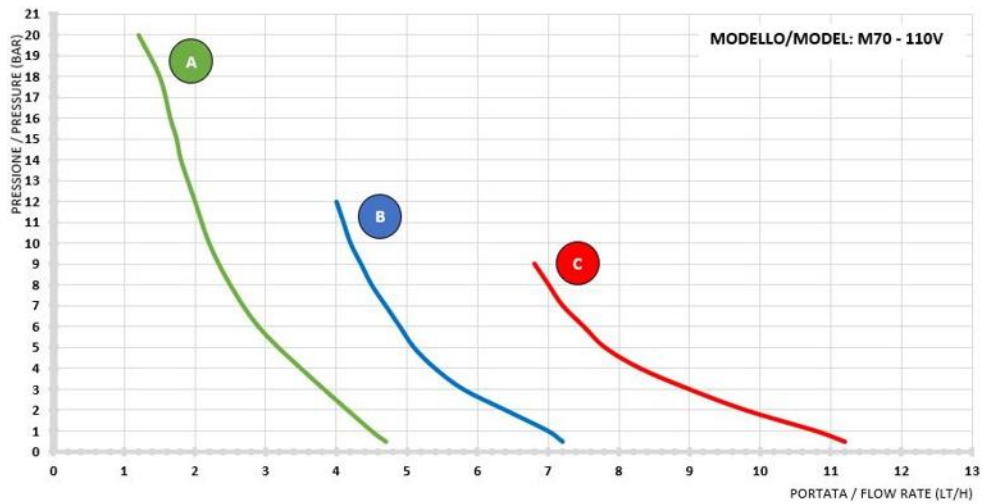
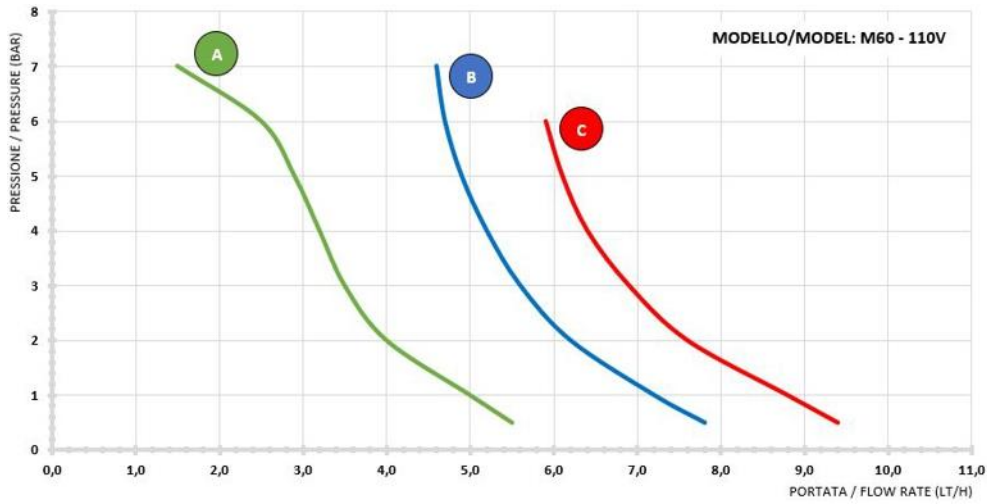

2.5 CONTENT OF THE PACKAGE (Standard version)

- IW-DOSE pump
- Quick Start Guide
- Injection valve PVDF-CE-VT
- Foot filter PVDF-PTFE-VT
- 2 meters PE discharge tube
- 2 meters PVC suction tube

- 2 meters PVC bleed valve tube (2 m)
- Fixing bracket
- Set of screws and plugs for wall mounting

3. IW-DOSE / IW-DOSE pH(Rx)-CI(J)

3.1 GENERIC PUMP CONTROLS

The control panel of the IW-DOSE pump is composed of a pump state leds (1) a multi-function button (2) which allows you to perform different actions and a led linked to the button functions. The figures below, show what the control panel looks like:



- 1. Pump state leds;
- 2. Multi-function button;
- 3. Led functions

3.2 MEANING OF THE PUMP STATE LEDS

		Pompa in funzione • Pump running • Pompe en fonctionnement • Bomba en funcionamiento • Pumpe in Funktion
		Stand-by
		Inhibit
		Allarme • Alarm • Alerte • Alarma • Warnung
		Stand-by fuori fascia oraria • Out of time stand-by • hors créneau horaire stand-by • stand-by fuera de horario • außerhalb der Stunde stand-by
		Aggiornamento firmware in corso • Firmware update in progress • Mise à jour du firmware en cours • Actualización de firmware en curso • Firmware Update in Arbeit
		Mancanza flusso • No flow • Manque de circulation • Falta de flujo • Fehlende Bereitstellung von Strom
		Ritardo allarme di livello • Level alarm delay • Délai d'alarme de niveau • Retardo de alarma de nivel • Level Alarm Verzögerung



Led rotanti / Rotating LEDs / Leds rotatives / Led giratorios / Rotierende Leds



Led lampeggianti / flashing LEDs / Leds clignotantes / Led intermitente / Blinkende LED'sotierende Leds













Dissolvenza / Fade out / Fondu / Desvanecimiento / Ausgeblendet

3.3 MEANING OF THE MULTI-FUNCTION BUTTON AND LED

The pump is equipped with a button (2) which has the following functions:

- If it is pressed for more than 5 seconds, the pump switches to “access point” mode (flashing white LED);
- If pressed between 1 and 2 seconds: stand-by is activated/deactivated; if the pump is in OFA alarm, this is reset;
- If it is pressed for a period of between 20 and 30 seconds, the factory settings of the access password are reset (fixed yellow LED);

		Attesa connessione al router • Waiting for router connection • En attente de connexion au routeur • Esperando la conexión del enrutador • Warten auf Router-Verbindung
		Connesso al router • Connected to router • Connecté au routeur • Conectado al enrutador • Mit Router verbunden
		Attesa connessione al cloud • Waiting for cloud connection • En attente de connexion au cloud • Esperando conexión a la nube • Warten auf Cloud-Verbindung
		Connesso al cloud • Connected to the cloud • Connecté au cloud • Conectado a la nube • Mit der Cloud verbunden
		Il dispositivo non risponde • The device is not responding • L'appareil ne répond pas • El dispositivo no responde • Das Gerät antwortet nicht
		Dispositivo in fase di inizializzazione • Device being initialized • Appareil en cours d'initialisation • Dispositivo siendo inicializado • Gerät wird initialisiert
		Reset password di accesso • Access password reset • Accéder à la réinitialisation du mot de passe • Restablecer contraseña de acceso • Zugang zum Zurücksetzen des Passworts

 Led lampeggianti / flashing LEDs / Leds clignotantes / Led intermitente / Blinkende LED's

 Led fisso / Fixed LED / DEL fixe / LED fijo / Feste LED

5. ELECTRICAL CONNECTIONS

5.1 IW-DOSE / IW-DOSE pH(Rx) / IW-DOSE CL pumps

There are several connectors on the bottom of the pump depending on the model of it, these allow the connection of an external signal coming from a pulse emitting water meter or a mA signal (IW-DOSE), a connection of a pH / ORP or free chlorine probe (IW-DOSE PH(Rx) / IW-DOSE CL). The pump is also equipped with a BNC connector for connecting a level probe (not included in the package).

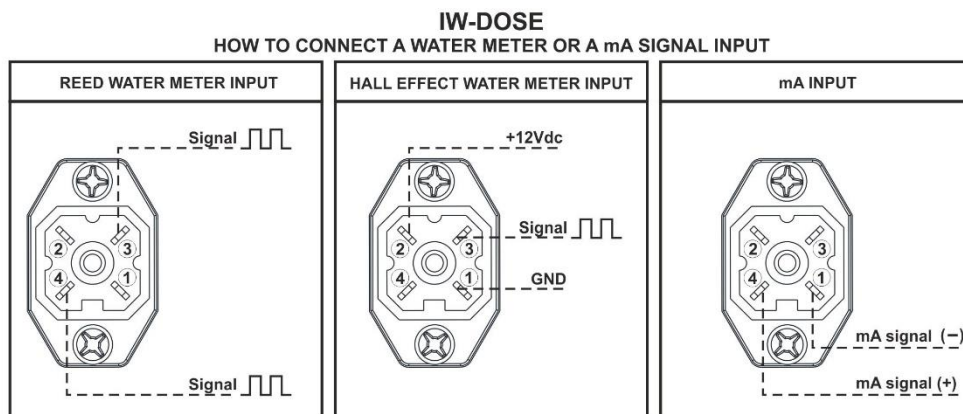
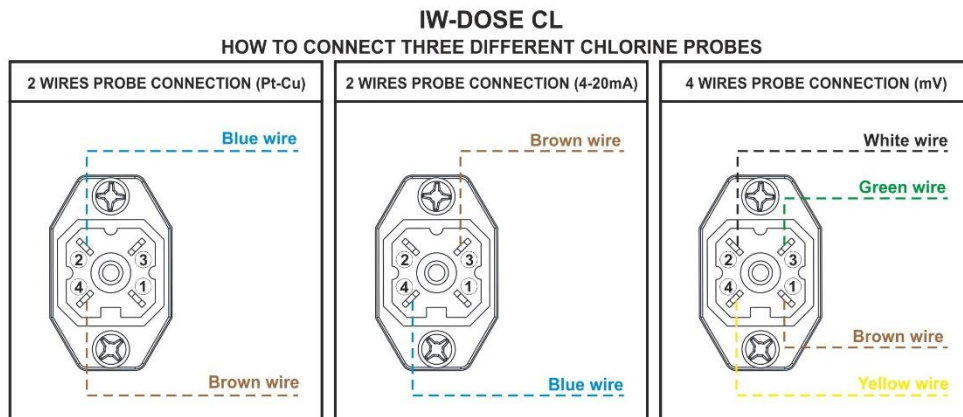
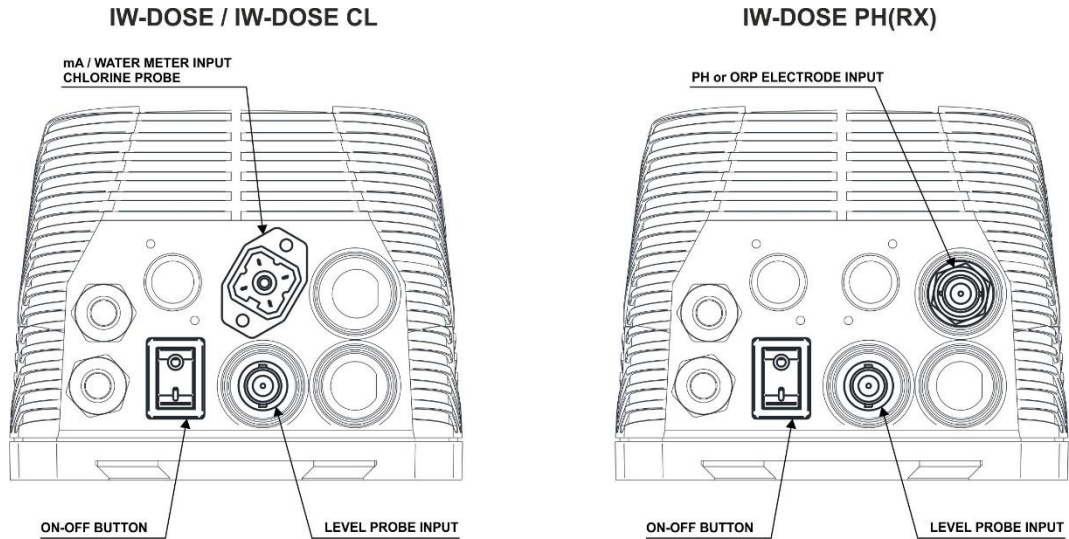

6. TROUBLESHOOTING

The solenoid driven dosing pump is a relatively robust device, therefore the chances of mechanical failures are low. Sometimes chemical leaks may occur from nipples or loose hose nuts of the pump head or simply due to breakage of the discharge pipe. If one of the above cases occurs, user has to first disconnect the unit from the power supply, then replaces the damaged part, cleans the unit from any chemical leaks, then restart the pump.

6.1 PROBLEM – CAUSE – SOLUTION

Below are listed some of the problems that may occur, the causes and solutions

PROBLEM	POSSIBLE CAUSE	SOLUTION
The pump does not switch on	The pump is not powered	Connect the pump to the mains.
	The protection fuse is blown up.	Replace the fuse.
	The electronic board is damaged	Replace the electronic board.
The pump does not dose but the solenoid is working	The foot filter is obstructed.	Clean the foot filter.
	The suction tube is empty, the pump is not primed.	Repeat the priming procedure.
	Air bubbles in the hydraulic circuit.	Check nipples and hoses
	The chemical in use generates gas	Open the bleed valve and let the air goes out. Replace the pump head with automatic bleed version.
The pump does not dose and the solenoid does not works or the stroke is greatly muffled.	Crystals formation, valve occlusion and / or the balls are blocked.	Clean the valves and try to circulate water instead of the chemical product.
	The injection valve is obstructed	Replace the valves of the pump head. Replace the injection valve.

7. MAINTENANCE

7.1 CLEANING THE PUMP

The pump must be periodically cleaned in order to ensure its efficiency. We suggest to carry out regular cleaning during maintenance period.

Before carrying out any maintenance or cleaning operations on the dosing pump, it is necessary to:

1. Make sure that it is electrically disabled (both polarities) by disconnecting the conductors from the contact points of the power supply by opening the omnipolar switch;
2. Eliminate in the most appropriate and gradual way, (paying the utmost attention not to generate splashes), the existing pressure in the pump body and in the delivery pipe, by opening the appropriate air bleed valve.
3. Remove the protective cover of the pump body, to highlight any underlying leaks and encrustations;
4. Clean any incrustations due to leaks or drips on the pump body or on the entire pump structure, paying particular attention to the lower part of the pump where, usually, any incrustations due to drips accumulate;
5. Reassemble the cover of the pump body, the delivery and suction pipes, close the air bleed valve and reconnect the pump electrically;
6. Carry out priming if necessary and restore the normal operating status of the pump.

7.2 PUMP MAINTENANCE

Under normal operating conditions, the metering pump should be checked monthly. To avoid malfunctions or sudden stops, carefully check the following items:

- check that the electrical and hydraulic connections are intact;*
- check for any leaks on the connections of the pump head or the injection valve;*
- check that there are no parts of the pump or pipes corroded.*

Always empty the pump head from chemical, if there could still be presence of dangerous chimica inside the pump head it is mandatory to declare it filling the RETURN MATERIAL AUTHORIZATION module. Always use original spare parts if it is necessary to replace worn parts

All technical assistance operations must be performed only by expert and authorized personnel. If the pump requires direct assistance from the manufacturer, it is necessary to remove all the liquid inside the pump head and dry it BEFORE packing it in its original box!

8. WARRANTY

The product is covered by the manufacturer's warranty for manufacturing defects. The methods and conditions are set forth in the "General Conditions of Sale" document of AQUA SpA.

EXPLODED VIEWS

GENERIC IW-DOSE

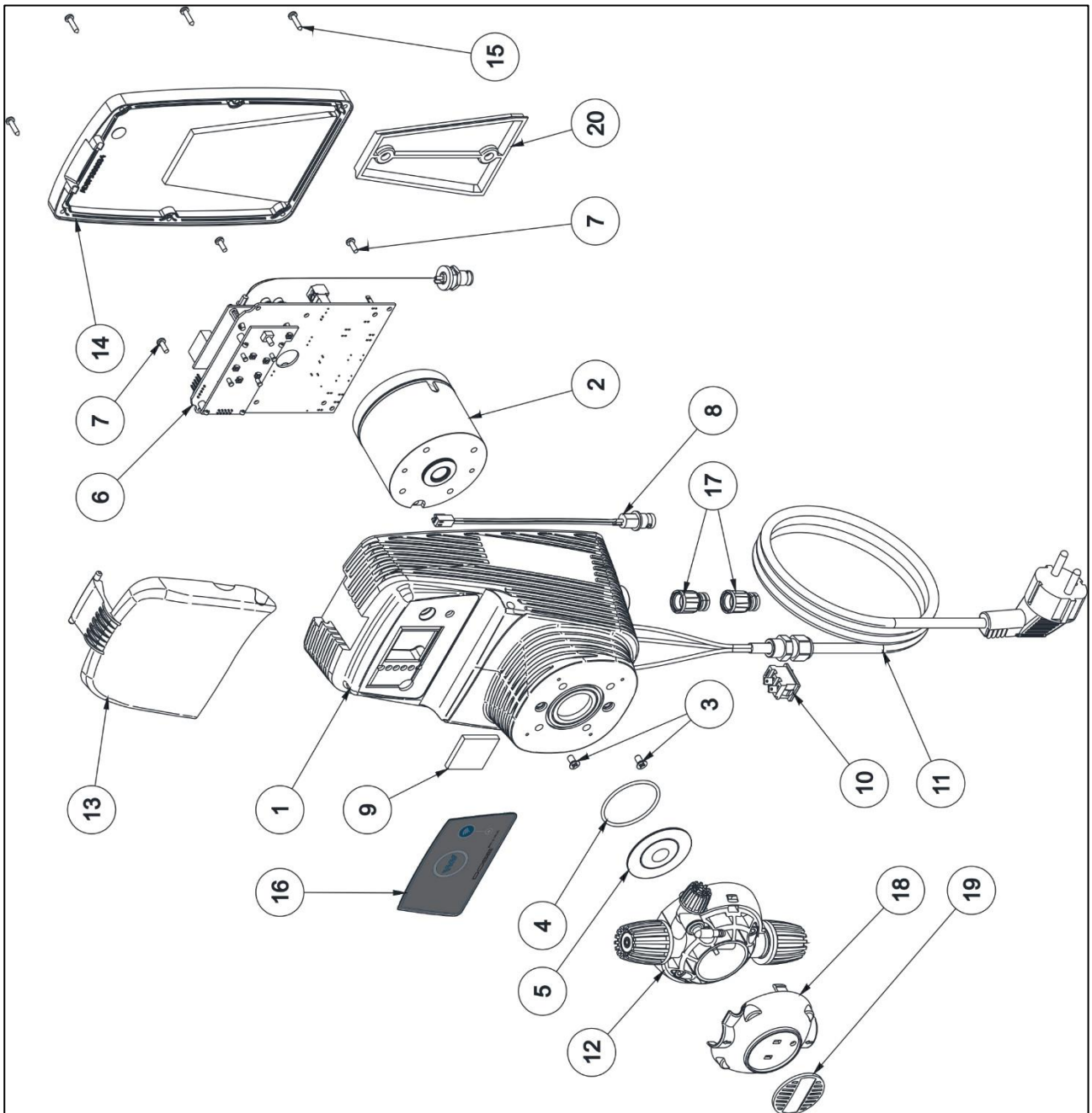

GENERIC IW-DOSE

N°	Codice Code	Descrizione Description	Quantità Quantities
1	ADSP9300058	CASSA HC151+ PP+20% FV NERA HC 151+ PP+20% GF BLACK HOUSING	1
2	ADSP6000295	MAGNETE COMPLETO D60 VERS.2 230V SILENZIOSO 230V D60 COMPLETE SOLENOID	1
2	ADSP6000287T	MAGNETE COMPLETO D70 230V – CORSA CORTA - SILENZIOSO 230V D70 COMPLETE SOLENOID	1
2	ADSP6000536	MAGNETE COMPLETO D80 4I/20bar 230V – (MOD.8) - SILENZIOSO 230V D80 COMPLETE SOLENOID	1
3	ADSP6000708	VITE M4X8 UNI 7688 (AF-TSTC) INOX A2 M4X8 UNI 7688 (AF-TSTC) SS A2 SCREW	2
4	ADSP5007133	OR – RIF. ORM0380-20	1
5	ADSP9200001	DIAFRAMMA PTFE DYNEON 1614/1645 1-14L HC897 M12x1 1614/1645 1-14L HC897 M12x1 PTFE DYNEON DIAPHRAGM	1
6	IWSKDRPDEDOS	SKD COMPLETA PDE IW-DOSE - ARIETE PDE IW-DOSE COMPLETE ELECTRONIC BOARD	1*
7	ADSP6000749	VITE 3x8 (TCTC) INOX A2 – SERIE HILO 3x8 SS A2 HILO SERIES SCREW	4
8	ADSP6000292	CONNETTORE BNC FEMMINA CONN.CRIMP. 2,54 L160 R/N CABLATO WIRED FEMALE BNC CONNECTOR L160 FOR LEVEL PROBE	1
9	IW15155	METACRILATO ESTRUSO OPALE SP.4mm PER LED OPAL EXTRUDED METHACRYLATE SP.4mm FOR LED	1
10	ADSP6000516	INTERRUTTORE ON/OFF 3A 250V TIPO A BILICO 3A 250V ON/OFF SWITCH	1
11	ADSP6020281A	CAVO H05VV-F 3x0,75 MT 3 N.2 FASTON 2,8x0,8 FEMMINA + N.1 FEM 4,8 + PG7 + SHUKO H05VV-F 3x0,75 POWER SUPPLY CABLE 3 METERS WITH PLUG	1
11	ADSP9000003	TARGHETTA NERA CON LOGO AQUA PER CORPO POMPA 1-14LT 1-14LT PUMP HEAD BLACK PLATE WITH LOGO AQUA	1
12	ADSP900P205	CORPO POMPA 1-14 PVDF-CE-VT COMPLETO 1-14 PVDF-CE-VT COMPLETE PUMP HEAD	1
12	ADSP900P006	CORPO POMPA 1-14 PVDF-CE-DT COMPLETO 1-14 PVDF-CE-DT COMPLETE PUMP HEAD	1
13	ADSP9300061	VETRINO TRASPARENTE HC151+ HC151+ TRANSPARENT FRONT COVER	1
14	ADSP9300034L	COPERCHIO POSTERIORE HC151 DGT PP NERO CON GUARNIZ. HC151 DGT PP BACK COVER WITH GASKET	1
15	ADSP6000714	VITE 2,9x13 UNI 6954 (TCTC) 2,9x13 UNI6954 SCREW	6
16	IW15325	ETICHETTA POLICARBONATO PDE IW-DOSE PH(RX) PDE IW-DOSE PH(RX) POLICARBONATE ADHESIVE LABEL	1
16	IW15315	ETICHETTA POLICARBONATO PDE IW-DOSE CL PDE IW-DOSE CL POLICARBONATE ADHESIVE LABEL	1
16	IW15300	ETICHETTA POLICARBONATO PDE IW-DOSE PDE IW-DOSE POLICARBONATE ADHESIVE LABEL	1
17	ADSP6000948	PROTEZIONE BNC FEMMINA DA PANNELLO GOMMA NERO BNC RUBBER PROTECTIVE CAP	2
18	ADSP9000022	COVER NERO CORPO POMPA 1-14LT HC897 1-14LT PUMP HEAD BLACK COVER	1
19	ADSP9000003	TARGHETTA NERA SENZA LOGO PER CORPO POMPA 1-14LT 1-14LT PUMP HEAD BLACK PLATE W/OUT LOGO	1
20	ADSP6020221	STAFFA FISSAGGIO A PARETE WALL FIXING BRACKET	1

*: depending on the pump model you have, when you order the IWSKDRPDEDOS electronic board you must also order 789STRPHRX0I board for the IW-DOSE PHRX version or 789STRCL00I board for the IW-DOSE CL version.

PUMP HEAD EXPLODED VIEW

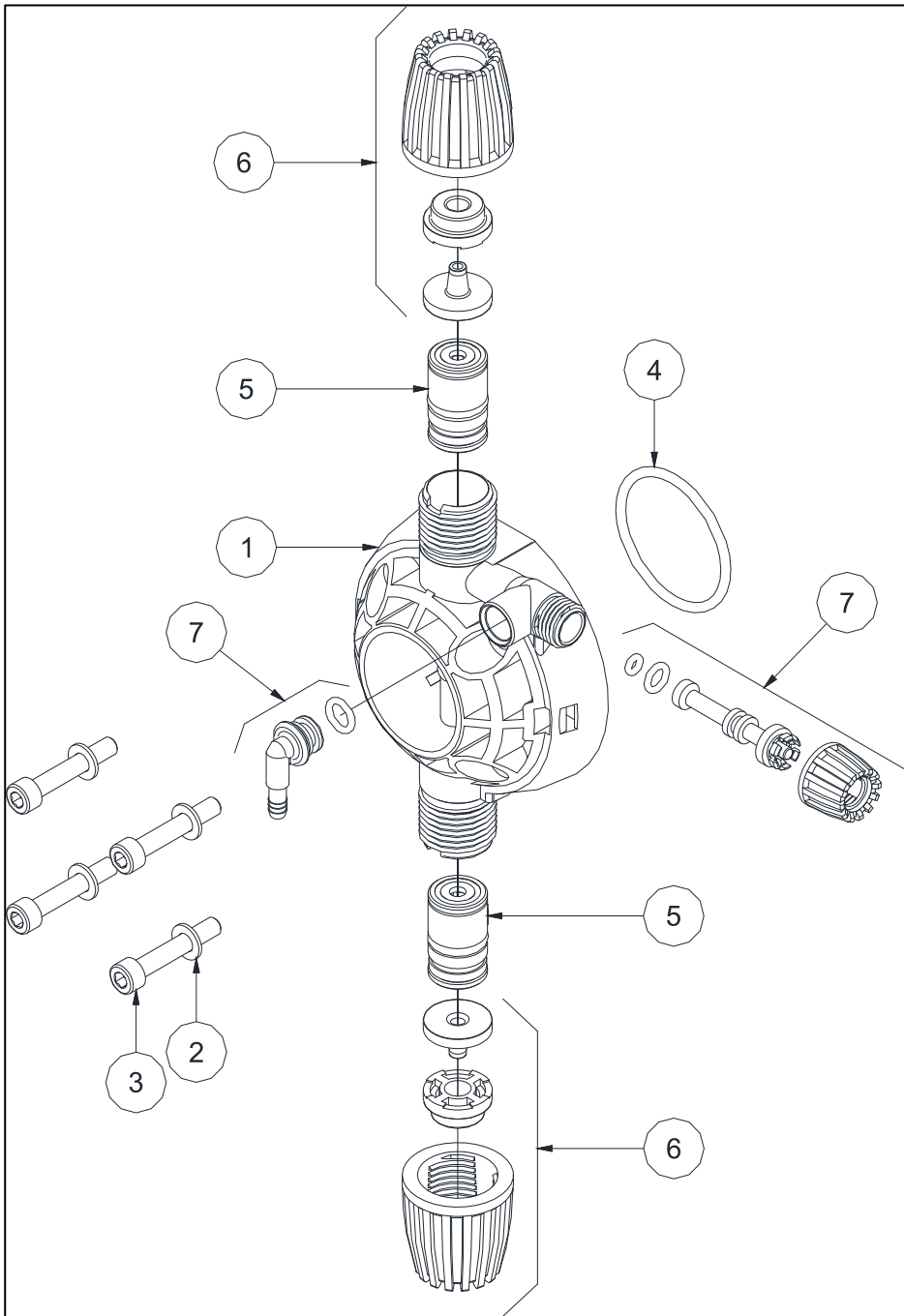

CORPO POMPA PP / PP PUMP HEAD



CORPO POMPA PVDF / PVDF PUMP HEAD



PUMP HEAD EXPLODED VIEW

N°	Codice Code	Descrizione Description	Quantità Quantities
1	ADSP9000001	CORPO POMPA 1-14 PP NERO HC897M (VN) <i>1-14 PP BLACK PUMP HEAD</i>	1
1	ADSP9000001P	CORPO POMPA 1-14 PVDF BIANCO HC897 <i>1-14 PVDF WHITE PUMP HEAD</i>	1
2	ADSP6000701	RONDELLA PIANA D. 5 – UNI 6592 INOX A2 <i>D.5 WASHER – UNI 6592 SS A2</i>	4
3	ADSP9000016	VITE M5x30 UNI 5931 (TCEI) INOX A2 <i>M5x30 UNI 5931 SS A2 SCREW</i>	4
4	ADSP5007200	OR – RIF. 3143 (T.2,62xD.36,14) – FPM NERO <i>FPM 3143 (T.2,62xD.36,14) ORING</i>	1
4	ADSP5007209	OR – RIF. 3143 (T.2,62xD.36,14) – EPDM NERO <i>EPDM 3143 (T.2,62xD.36,14) ORING</i>	1
5	ADSP9005010	KIT GRUPPO VALVOLA ½" PP-GL-VT <i>½" PP-GL-VT VALVE KIT</i>	1
5	ADSP9005011	KIT GRUPPO VALVOLA ½" PP-GL-DT <i>½" PP-GL-DT VALVE KIT</i>	1
5	ADSP9005P12	KIT GRUPPO VALVOLA ½" PVDF-CE-VT <i>½" PVDF-CE-VT VALVE KIT</i>	1
5	ADSP9005P13	KIT GRUPPO VALVOLA ½" PVDF-CE-DT <i>½" PVDF-CE-DT VALVE KIT</i>	1
6	ADSP6500059	KIT FISSAGGIO PP ½" PER TUBO 4x6 <i>½" PP FIXING KIT FOR 4x6 HOSE</i>	1
6	ADSP6500060	KIT FISSAGGIO PVDF ½" PER TUBO 4x6 <i>½" PVDF FIXING KIT FOR 4x6 HOSE</i>	1
6	ADSP6500067	KIT ATTACCO TUBO 6x8 CON GHIERA DA ½" PP NERA <i>6x8 FIXING KIT WITH ½" BLACK PP HOSE NUT</i>	2
6	ADSP6500068	KIT ATTACCO TUBO 6x9 CON GHIERA DA ½" PP NERA <i>6x8 FIXING KIT WITH ½" BLACK PP HOSE NUT L</i>	2
6	ADSP6500063	KIT ATTACCO TUBO 6x10 CON GHIERA DA ½" PP NERA <i>6x8 FIXING KIT WITH ½" BLACK PP HOSE NUT</i>	2
7	ADSP6500072	KIT VITE SPURGO + PORTAGOMMA PP-VT CORPO POMPA <i>AIR BLEED KIT + PP-VT HOSE FITTING FOR PUMP HEAD</i>	1
7	ADSP6500072P	KIT VITE SPURGO + PORTAGOMMA PVDF-VT CORPO POMPA <i>AIR BLEED KIT + PP-VT HOSE FITTING FOR PUMP HEAD</i>	1
7	ADSP6500073	KIT VITE SPURGO + PORTAGOMMA PP-DT CORPO POMPA <i>AIR BLEED KIT + PP-DT HOSE FITTING FOR PUMP HEAD</i>	1
7	ADSP650073P	KIT VITE SPURGO + PORTAGOMMA PVDF-DT CORPO POMPA <i>AIR BLEED KIT + PVDF-DT HOSE FITTING FOR PUMP HEAD</i>	1

AUTO BLEED PUMP HEAD EXPLODED VIEW

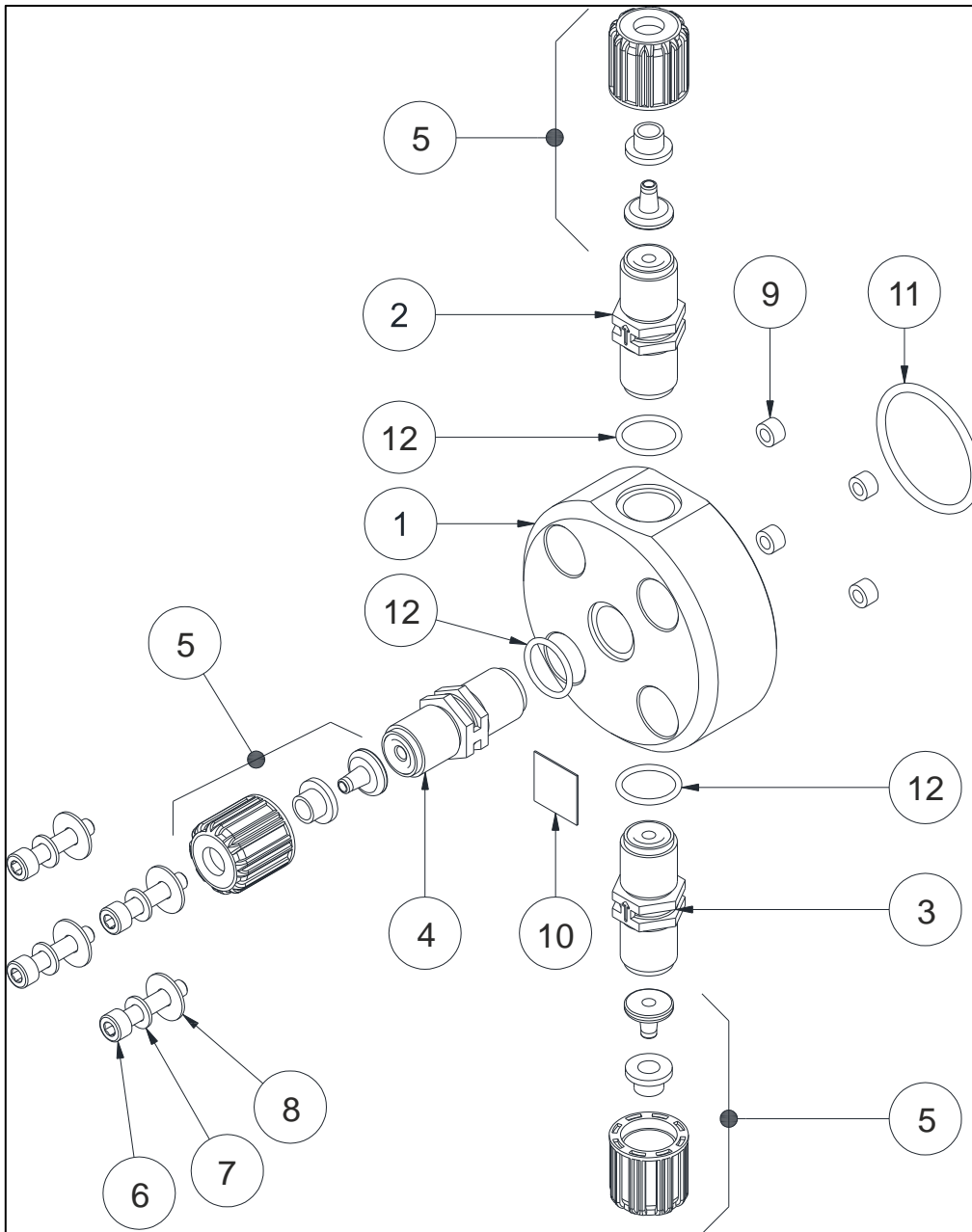

AUTO BLEED PUMP HEAD EXPLODED VIEW

N°	Codice Code	Descrizione Description	Quantità Quantities
1	ADSP9000029	CORPO POMPA 1-14 PVC SPURGO AUTOMATICO 1-14 PVC AUTO BLEED PUMP HEAD	1
2	ADSP5005033	GRUPPO VALVOLA 3/8" PER SPURGO PP-CE-VT 3/8" PP-CE-VT DEGAS VALVE KIT	1
2	ADSP5005133	GRUPPO VALVOLA 3/8" PER SPURGO PP-CE-DT (OR2015 PTFE) 3/8" PP-CE-DT DEGAS VALVE KIT	1
2	ADSP5005036	GRUPPO VALVOLA 3/8" PER SPURGO PVDF-CE-VT 3/8" PVDF-CE-VT DEGAS VALVE KIT	1
2	ADSP5005038	GRUPPO VALVOLA 3/8" PER SPURGO PVDF-CE-DT 3/8" PVDF-CE-DT DEGAS VALVE KIT	1
3	ADSP5005031	GRUPPO VALVOLA 3/8" PP-CE-VT 3/8" PP-CE-VT VALVE KIT	1
3	ADSP5005131	GRUPPO VALVOLA 3/8" PP-CE-DT 3/8" PP-CE-DT VALVE KIT	1
3	ADSP5005034	GRUPPO VALVOLA 3/8" PVDF-CE-VT 3/8" PVDF-CE-VT VALVE KIT	1
3	ADSP5005037	GRUPPO VALVOLA 3/8" PVDF-CE-DT 3/8" PVDF-CE-DT VALVE KIT	1
4	ADSP5005032	GRUPPO VALVOLA 3/8" PP-CE-HAST-VT 3/8" PP-CE-HAST-VT VALVE KIT	1
4	ADSP5005132	GRUPPO VALVOLA 3/8" PP-CE-HAST-DT 3/8" PP-CE-HAST-DT VALVE KIT	1
4	ADSP5005035	GRUPPO VALVOLA 3/8" PVDF-CE-HAST-VT 3/8" PVDF-CE-HAST-VT VALVE KIT	1
4	ADSP5005135	GRUPPO VALVOLA 3/8" PVDF-CE-HAST-DT 3/8" PVDF-CE-HAST-DT VALVE KIT	1
5	ADSP6500048	KIT FISSAGGIO PP 3/8" PER TUBO 4X6 3/8" PP FIXING KIT FOR 4X6 HOSE	3
5	ADSP6500013	KIT FISSAGGIO PVDF 3/8" PER TUBO 4X6 3/8" PVDF FIXING KIT FOR 4X6 HOSE	3
6	MB010040	VITE M5x25 UNI 5931 (TCEI) INOX A2 M5x25 UNI 5931 SS A2 SCREW	4
7	ADSP6000701	RONDELLA PIANA D. 5 – UNI 6592 INOX A2 D. 5 WASHER – UNI 6592 SS A2	4
8	MB010460	RONDELLA PIANA 5x15 – UNI 6592 INOX A2 5x15 WASHER – UNI 6592 SS A2	4
9	ADSP5007011	BUSSOLA PER CORPO POMPA D. 3,2 x 6,45 x 5,5 SANT64A PUMP HEAD SCREW GASKET D. 3,2 x 6,45 x 5,5 SANT64A	4
10	ADSP7000442	ETICHETTA FLOW PER COLLARE PORTASONDA DN50-63 FLOW DIRECTION LABEL	1
11	ADSP5007200	OR – RIF. 3143 (T.2,62 x D.36,14) FPM NERO FPM 3143 (T.2,62 x D.36,14) ORING	1
11	ADSP5007209	OR – RIF. 3143 (T.2,62 x D.36,14) EPDM NERO EPDM 3143 (T.2,62 x D.36,14) ORING	1
12	ADSP5007001	OR – RIF. 2062 – FPM NERO FPM 2062 - ORING	3
12	ADSP5007002	OR – RIF. 2062 – EPDM NERO EPDM 2062 - ORING	3



INSIDE WATER

è un brand di :

AQUA SPA

Via Tonino Crotti, 1 - 42018 San Martino in Rio (RE) - Italy